

Trifase - Doppia cella a libro

Filtri per convertitori/inverter
Compatti, leggeri
Formato a libro
Correnti nominali da 10 a 120A
Alta attenuazione

Threephase - Double stage bookshelf design

3 phase filters for drives/inverters
Compact, lightweight
Bookshelf design
10-120A current rating
High insertion loss



MODELLI Model List	Codice Code	Corrente nom. rms [A] Rated current rms	Tensione nom. [V] Rated voltage	Capacità [µF] Capacitance				R [kΩ/W]	L1 [mH]	L2 [mH]	Ta* [C°]	Morsetto [mm²] Screw terminal	Corrente di fuga [mA]** Leakage current
				C _{x1}	C _{x2}	C _{x3}	C _{y1} C _{y2}						
TDCM10	2390TDCM10	10	3 x 520	1	1	1	0.027	680/1	3x6	3x6	-25+85	0.2 - 4.0	9mA max @ 520Vac
TDCM20	2390TDCM20	20		1	1	1	0.027	680/1	3x5	3x5		0.2 - 4.0	
TDCM35	2390TDCM35	35		2.2	2.2	2.2	0.027	470/1	3x2	3x2		0.2 - 6.0	
TDCM55	2390TDCM55	55		1	1	1	0.027	680/1	3x0.6	3x0.6		0.2 - 10.0	
TDCM75	2390TDCM75	75		2.2	2.2	2.2	0.027	470/1	3x0.8	3x0.8		0.2 - 16.0	
TDCM100	239TDCM100	100		4.7	4.7	4.7	0.027	330/2	3x0.5	3x0.5		10.0 - 25.0	
TDCM120***	239TDCM120	120		4.7	4.7	4.7	0.027	330/2	3x0.3	3x0.3		10.0 - 50.0	

*con corrente nominale - with rated current **di ogni fase verso terra - each line to ground ***no cURus

SPECIFICHE TECNICHE - Specifications

Tensione d'ingresso - Rated voltage	300-520 Vac
Campo di frequenza - Operating frequency	50±60 Hz
Corrente di fuga - Leakage current	max. 6 mA (@ 300 Vac), max. 9 mA (@ 520 Vac)
Categoria climatica - Climatic category	25/85/21(IEC 60068)
Tensione di prova AC (1 min.) - Test voltage AC (1 min.)	Fase/Terra: 2250 Vdc; Fase/Fase: 1450 Vdc - Line/Ground: 2250 Vdc; Line/Line:1450 Vdc
Sovraccaricabilità - Current overload	6 x corrente nom. per 8 sec. - 4 x rated current for 8 sec.
Isolamento - Insulation resistance	> 50 MΩ @500 Vdc (qualsiasi ingresso o uscita verso terra - any input or output to ground)
Grado di protezione - IP protection	IP 20 secondo EN 60529 - IP 20 according to EN 60529
Allacciamento - Connections	Morsetti a vite - Screw terminals
Montaggio - Mounting	Collegamento in serie tra la rete ed il carico. Montaggio su piastra. Mounted in series between the line and the load. Panel mounting.
Standard di riferimento - Reference standards	EN 60939 - UL 1283 - C22.2 No.8

DIMENSIONI [mm] - Dimensions [mm]

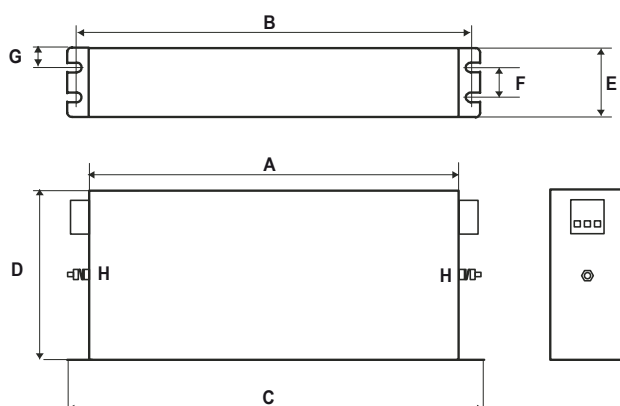

Modelli Models	A	B	C	D	E	F	G	H
10A	115	130.2	145	65	50	36	5.2	M4
20A	150	165.2	180	66	66	52	5.2	M4
35A	200	217.2	230	82	76	57	7.2	M4
55A	160	175.2	190	76	70	56	5.2	M4
75A	233	250.2	263	93	88	69	7.2	M6
100A	320	337.2	350	135	135	115	7.2	M6
120A	320	337.2	350	135	135	115	7.2	M6

Trifase con neutro Doppia cella a libro

Filtri trifase con neutro per convertitori/inverters
 Compatti, leggeri
 Formato a libro
 Correnti nominali da 10 a 100A
 Alta attenuazione

Threephase Double stage bookshelf design

3 phase **with neutral** filters for drives/inverters
 Compact, lightweight
 Bookshelf design
 10-100A current rating
 High insertion loss



MODELLI Model List	Codice Code	Corrente nom. rms [A] Rated current rms	Tensione nom. [V] Rated voltage	Capacità [µF] Capacitance		R [kΩ/W]	L1 [mH]	L2 [mH]	L3 [uH]	Ta* [C°]	Morsetto [mm²] Screw terminal	Corrente di fuga [mA]** Leakage current
				C _x	C _y							
NETM10	2390NETM10	10	3 x 520	1x9	0.01x8	680/1	4 x 3.5	4 x 3.5	4 x 50		0.2 - 4.0	21mA max @520Vac
NETM20	2390NETM20	20		1x9	0.01x8	680/1	4 x 3	4 x 3	4 x 30		0.2 - 6.0	
NETM55	2390NETM55	55		1x9	0.01x8	680/1	4 x 0.6	4 x 0.6	4 x 20	-25+50	0.2 - 16.0	
NETM75	2390NETM75	75		2.2x9	0.01x8	470/1	4 x 0.6	4 x 0.6	4 x 20		10.0 - 25.0	
NETM100	239NETM100	100		2.2x9	0.01x8	470/1	4 x 0.4	4 x 0.4	4 x 20		10.0 - 25.0	

*con corrente nominale - with rated current **di ogni fase verso terra - each line to ground

SPECIFICHE TECNICHE - Specifications	
Tensione d'ingresso - Rated voltage	300-520 Vac
Campo di frequenza - Operating frequency	50±60 Hz
Corrente di fuga - Leakage current	max. 14mA (@ 300 Vac), max. 21mA (@ 520 Vac)
Categoria climatica - Climatic category	25/85/21(IEC 60068)
Tensione di prova AC (1 min.) - Test voltage AC (1 min.)	Fase/Terra: 2250 Vdc; Fase/Fase: 1450 Vdc - Line/Ground: 2250 Vdc; Line/Line:1450 Vdc
Sovraccaricabilità - Current overload	6 x corrente nom. per 8 sec. - 6 x rated current for 8 sec.
Isolamento - Insulation resistance	> 50 MΩ @500 Vdc (qualsiasi ingresso o uscita verso terra - any input or output to ground)
Grado di protezione - IP protection	IP 20 secondo EN 60529 - IP 20 according to EN 60529
Allacciamento - Connections	Morsetti a vite - Screw terminals
Installazione e Montaggio - Installation and Mounting	Collegamento in serie tra la rete ed il carico. Montaggio su piastra. Mounted in series between the line and the load. Panel mounting.
Standard di riferimento - Reference standards	EN 60939 - UL 1283 - C22.2 No.8

DIMENSIONI [mm] - Dimensions [mm]

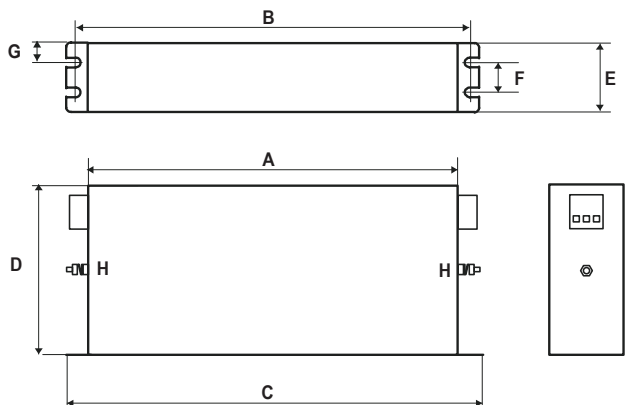

Modelli Models	A	B	C	D	E	F	G	H
10A	150	165.2	180	66	66	52	5.2	M4
20A	200	217.2	230	82	76	57	7.2	M4
55A	233	250.2	263	93	88	69	7.2	M6
75A	320	337.2	350	135	135	115	7.2	M6
100A	320	337.2	350	135	135	135	7.2	M6

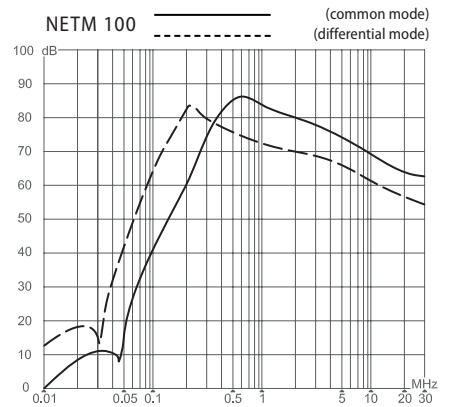
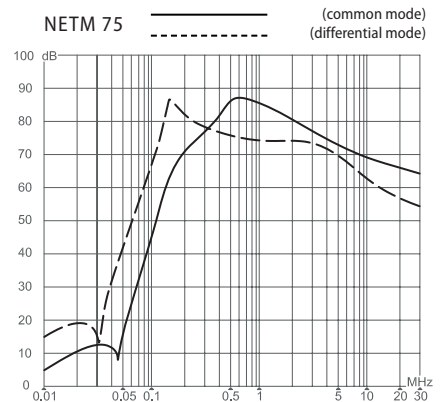
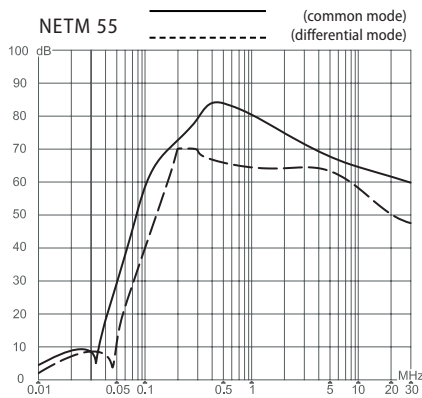
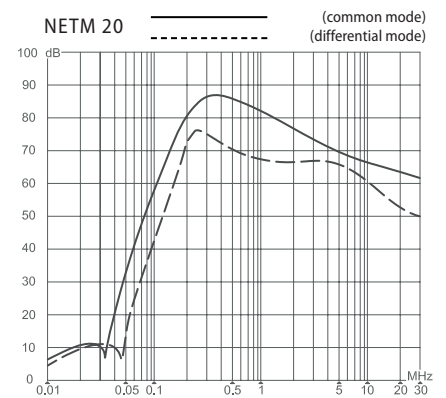
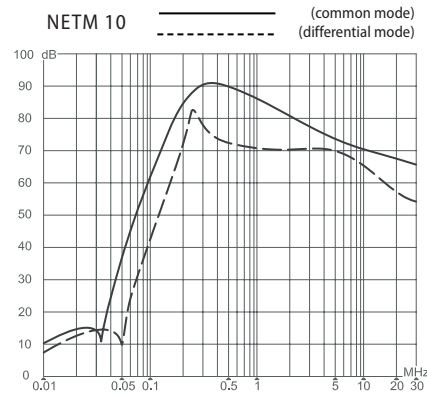

SCHEMA ELETTRICO - Electric schematic

